

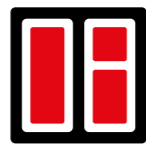

20
years of experience



2000
windows per day



250+
employees



ul. Północna 50A
16-400 Suwałki



(+48 87) 562-69-69



stollar@stollar.pl



@stollarpolska

ALUMINIUM
Window catalogue

Home is a very important place in everyone's life.

This is why we do our absolute best to ensure that the quality of our windows will satisfy the most demanding tastes.

We want your home to be a place of beauty and charm, where warmth and elegance are always at home thanks to our windows.

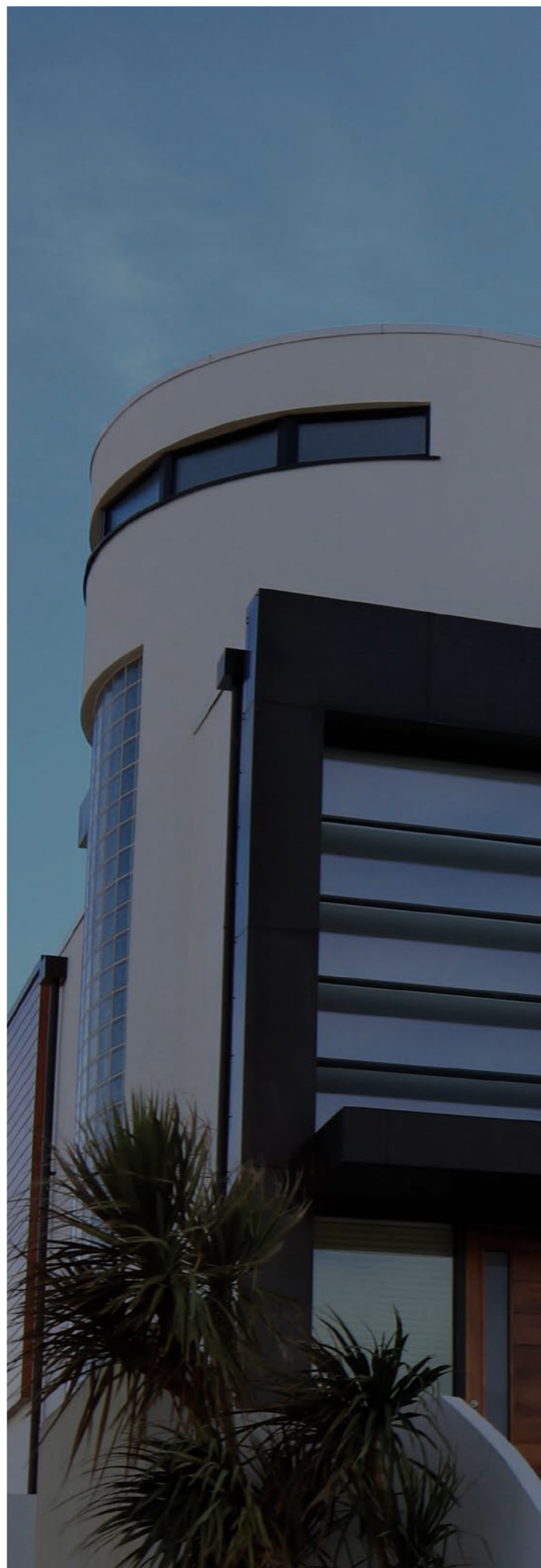
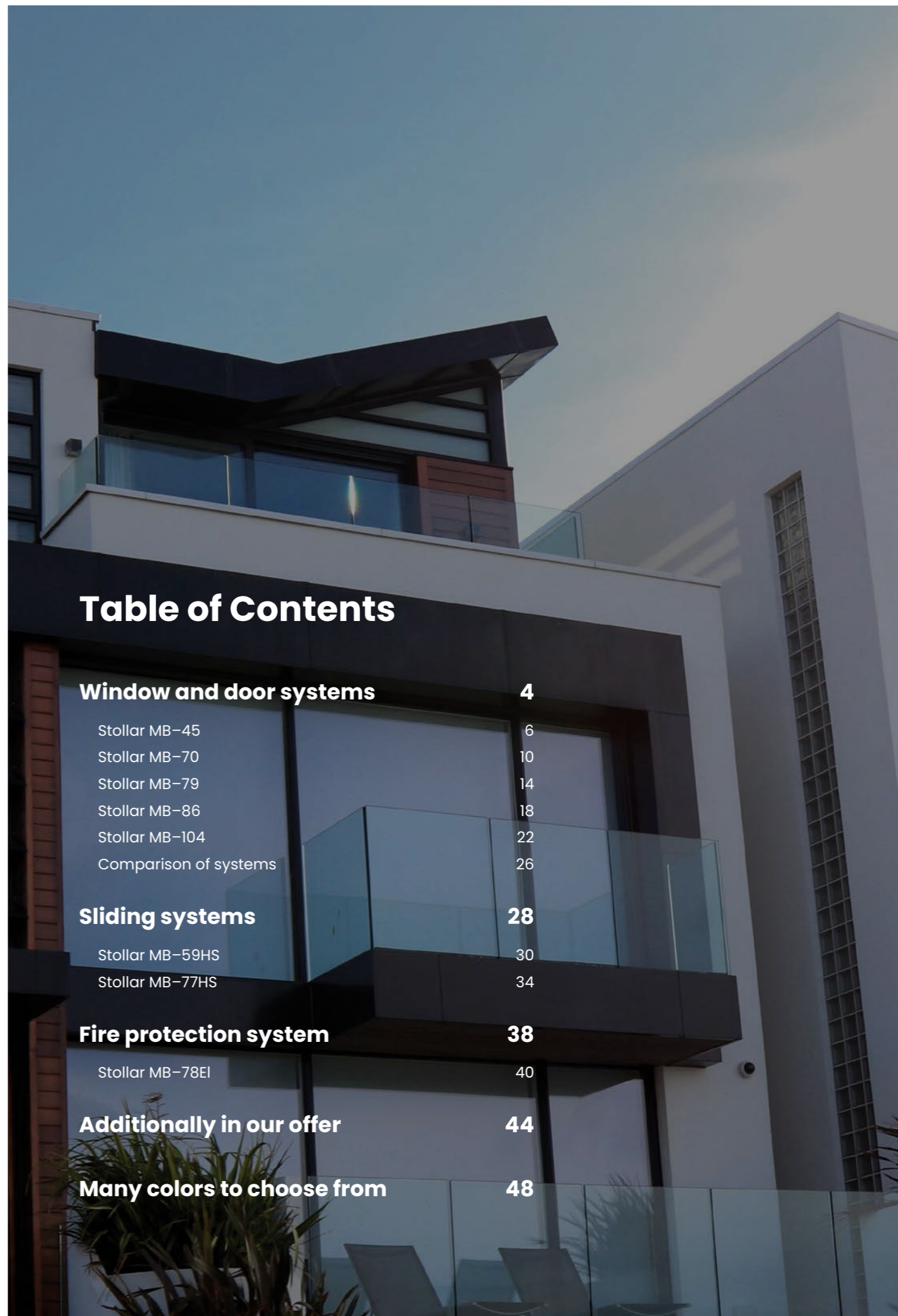
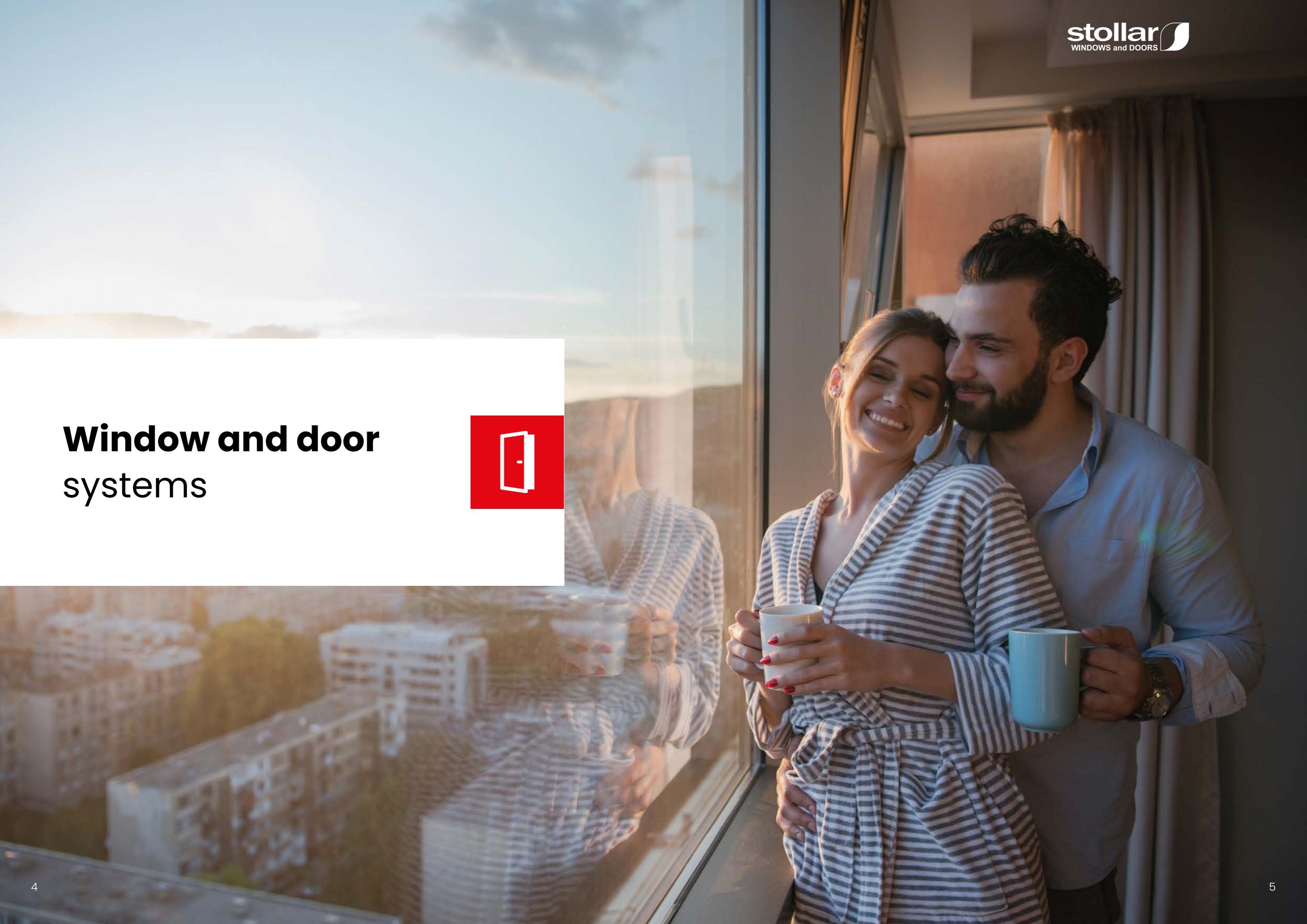

Table of Contents

Window and door systems	4
Stollar MB-45	6
Stollar MB-70	10
Stollar MB-79	14
Stollar MB-86	18
Stollar MB-104	22
Comparison of systems	26
Sliding systems	28
Stollar MB-59HS	30
Stollar MB-77HS	34
Fire protection system	38
Stollar MB-78EI	40
Additionally in our offer	44
Many colors to choose from	48



Window and door systems



Stollar MB-45



fot. Aluprof

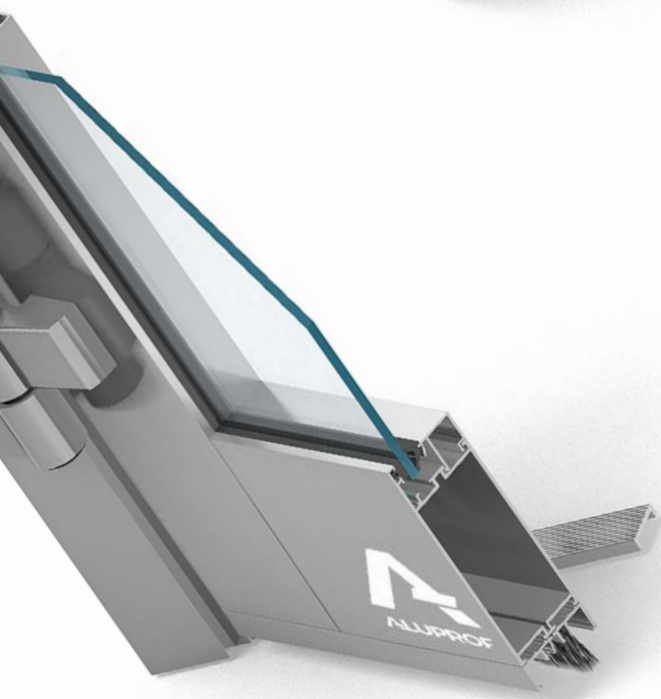

2 mm–25 mm



45 mm



120 kg



The system is primarily used for internal construction elements – various types of partition walls, windows, doors – including sliding, swing type windows and automatic doors, vestibules, display windows, cashier boxes, showcases, etc.



The maximum dimensions of the sash for the entrance door:

- L to 1400 mm
- H to 2400 mm



Possibility to make all-glass walls and doors in MB-45 OFFICE system.

Stollar MB-45

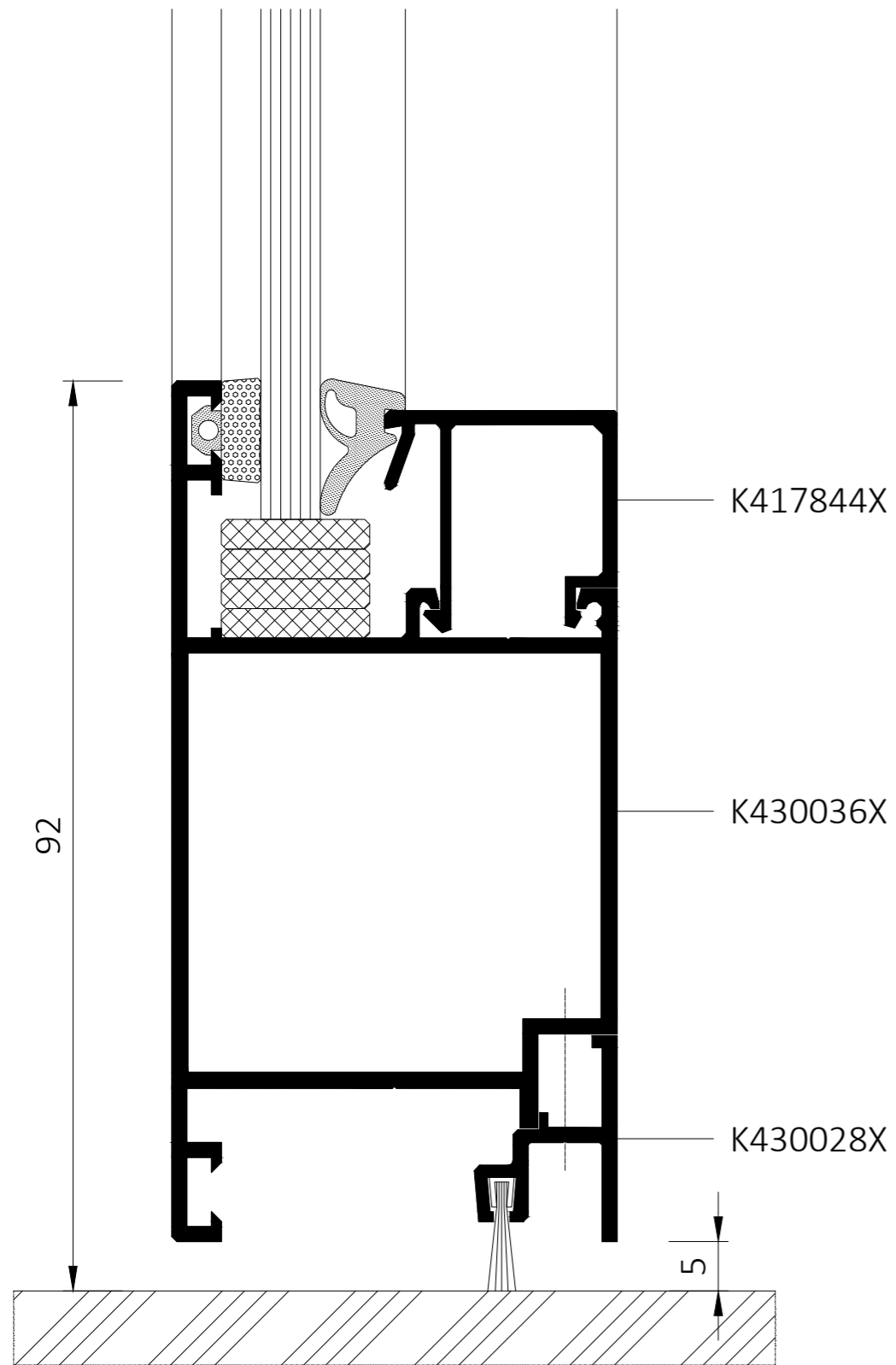

The constructional depth of the door sections is 45 mm. The depths of the leaf and frame sections adopted in this way gives an effect of one plane. The shape of the profiles allows to obtain slender and durable door structures.

Stollar MB-70

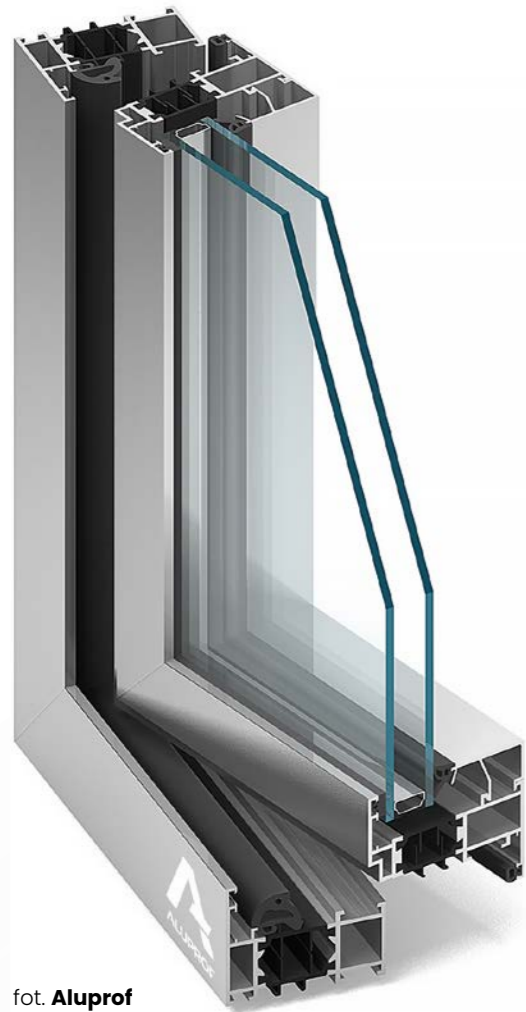

fot. Aluprof

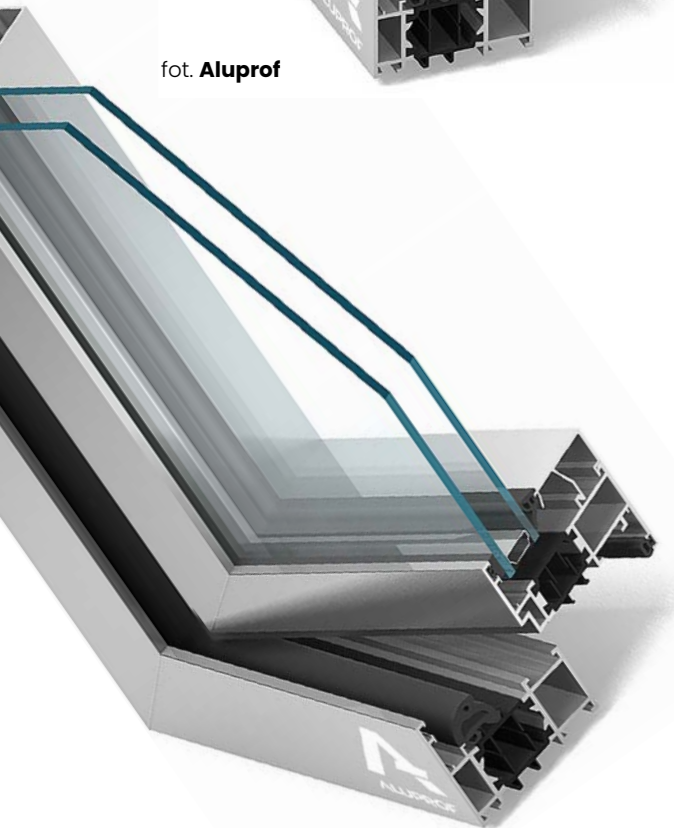

$U_f = > 1,0 \text{ W}/(\text{m}^2\text{K})$



70 mm



120 / 130 kg



An aluminium system used to make exterior architectural elements requiring very good thermal and acoustic insulation, e.g.: various types of windows, doors, vestibules, shop windows, spatial structures.



Maximum dimensions of the window sash:

- L to 1600 mm
- H to 2500 mm



Maximum dimensions of the door sash:

- L to 1300 mm
- H to 2400 mm



Glazing thickness:

- frame: 15–53 mm
- window sash: 24–62 mm
- door sash: 15–53 mm

Stollar MB-70

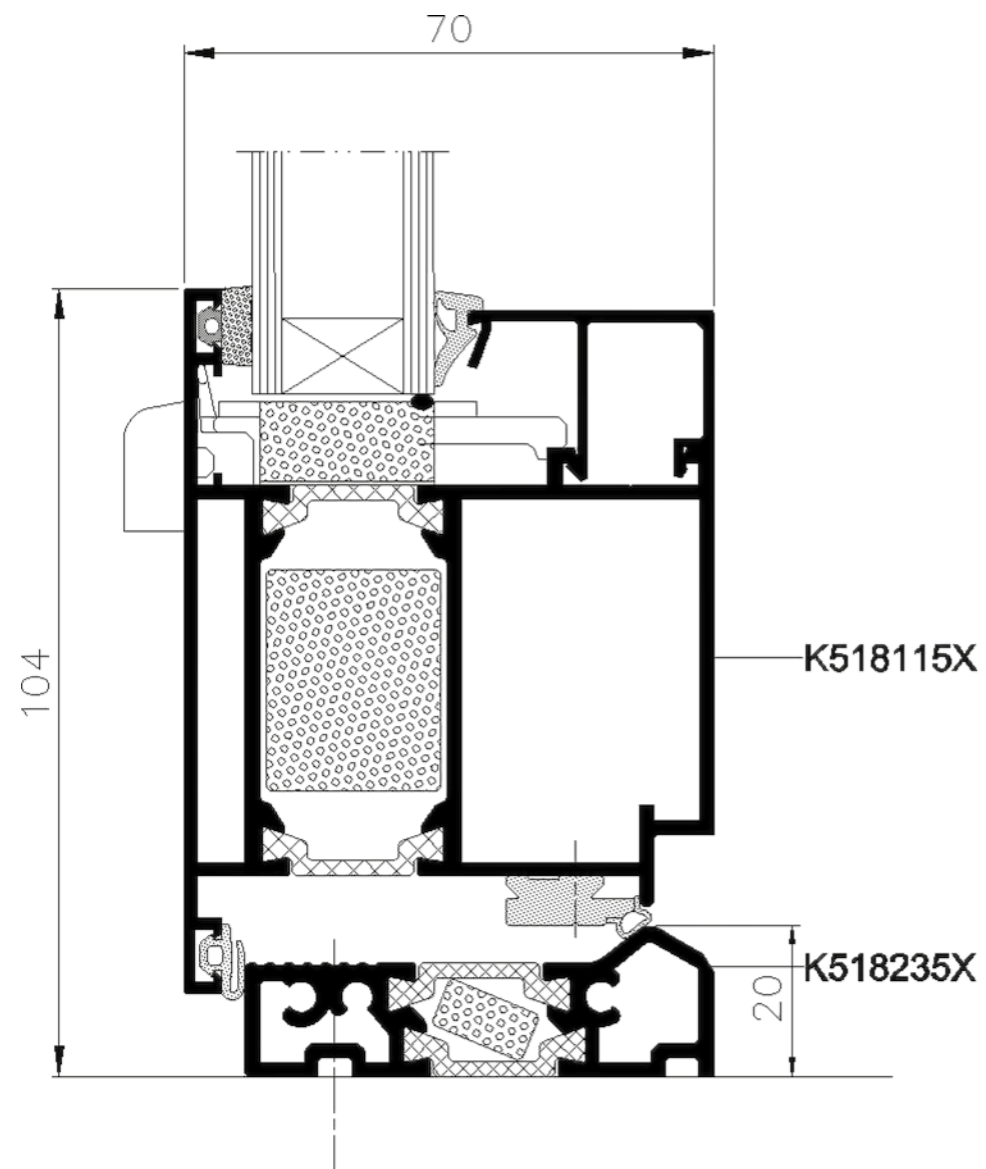

It has a version with increased thermal insulation, obtained thanks to the use of special insulating inserts inside the profiles and in the under-glass space.

There are also different versions of windows: a window with the so-called "The hidden sash" of the MB-70US.

It is also the basis for the MB70 CASEMENT system construction – outward opening windows.

Stollar MB-79



fol. Aluprof

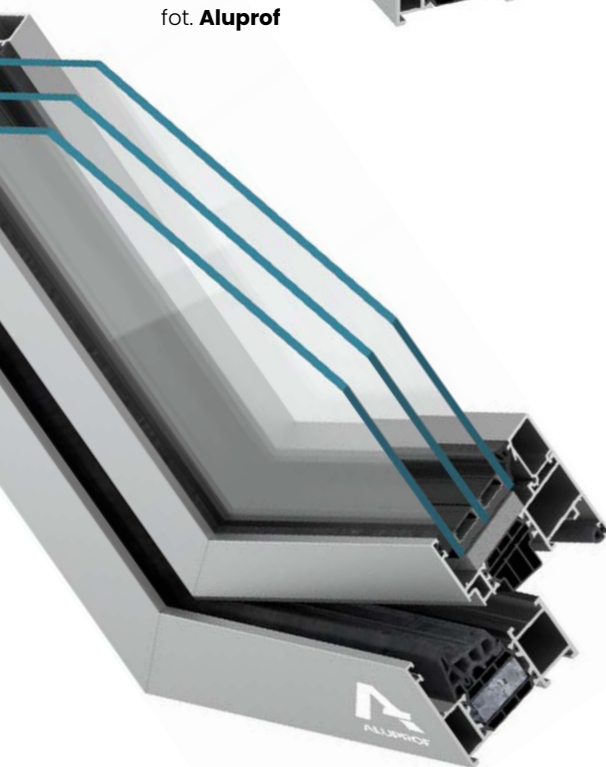

$$U_f = > 0,83 \text{ W}/(\text{m}^2\text{K})$$



70 mm



160 / 200 kg



This is the most modern, economical window and door system on offer. It has been introduced to meet increased thermal insulation requirements. It is used to make structures including: fixed, tilt, turn, tilt & turn, tilt & slide windows, as well as single and double-sash external doors.

- ✔ Maximum dimensions of the window sash:
 - L to 1700 mm
 - H to 2700 mm
- ✔ Maximum dimensions of the door sash:
 - L to 1400 mm
 - H to 2800 mm
- ✔ Glazing thickness:
 - frame: 2–54 mm
 - window sash: 11–63 mm
 - door sash: 2–54 mm

Stollar MB-79

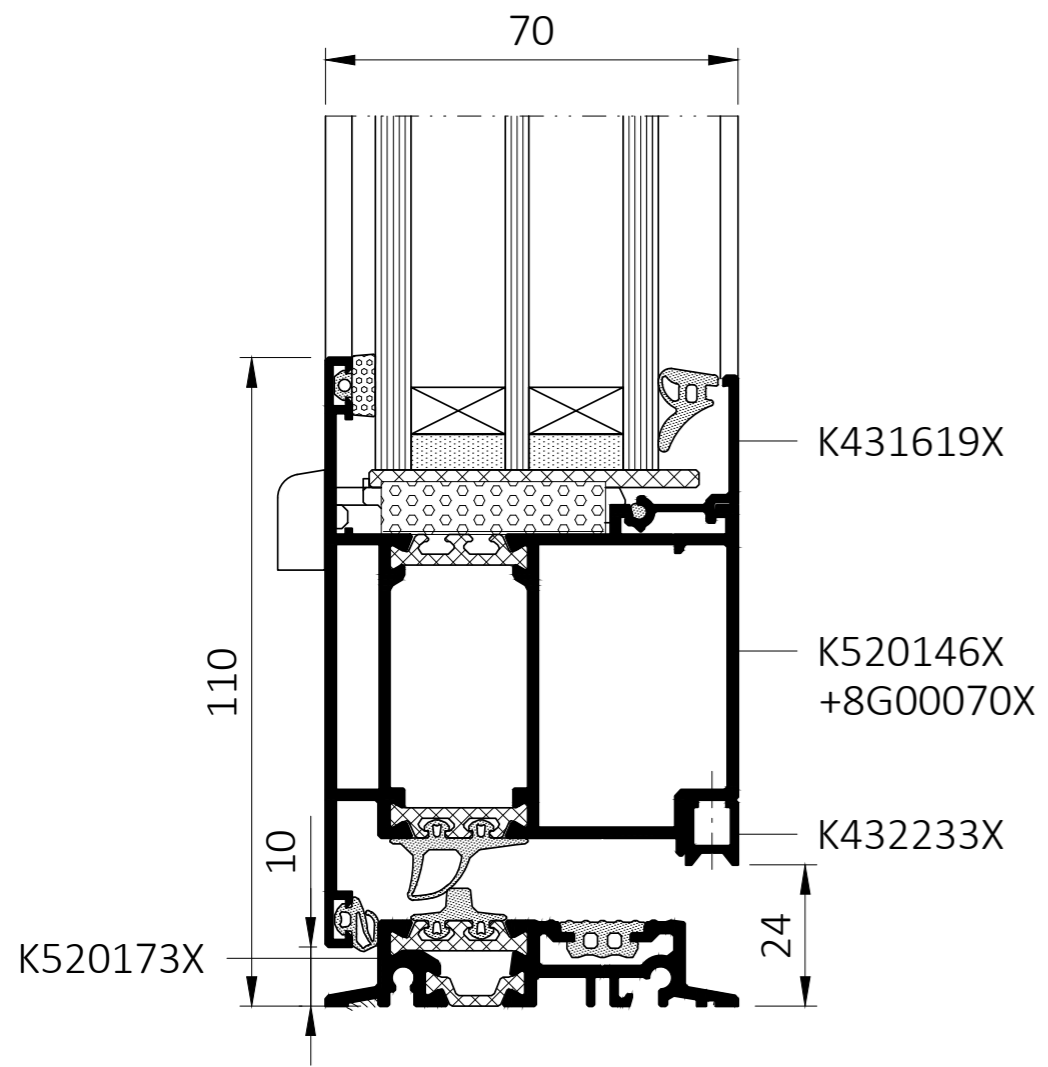

3 thermal construction variants for windows (MB-79N E, MB-79N ST, MB-79N SI) and 3 variants for doors (MB-79N ST, MB-79N SI and MB-79N SI+).

Stollar MB-86



foto. Aluprof

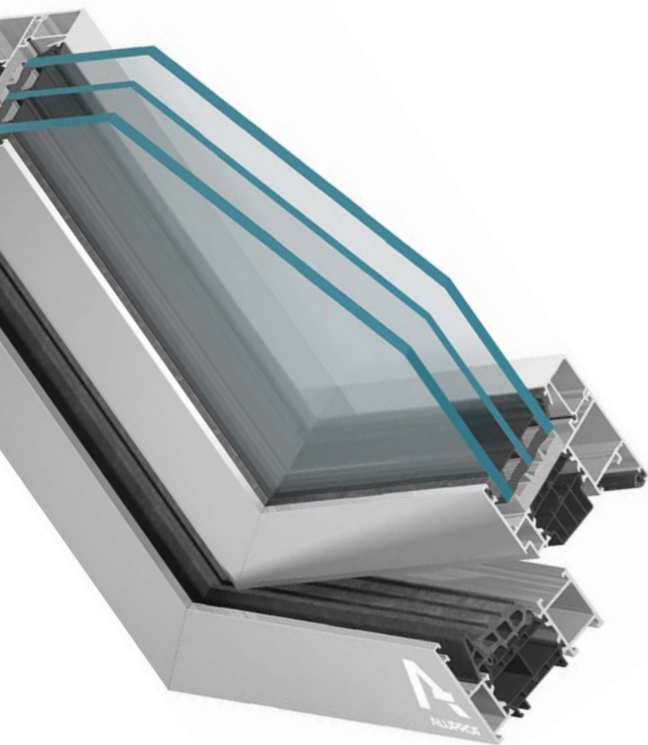



$U_w = > 0,72 \text{ W}/(\text{m}^2\text{K})$

77 mm

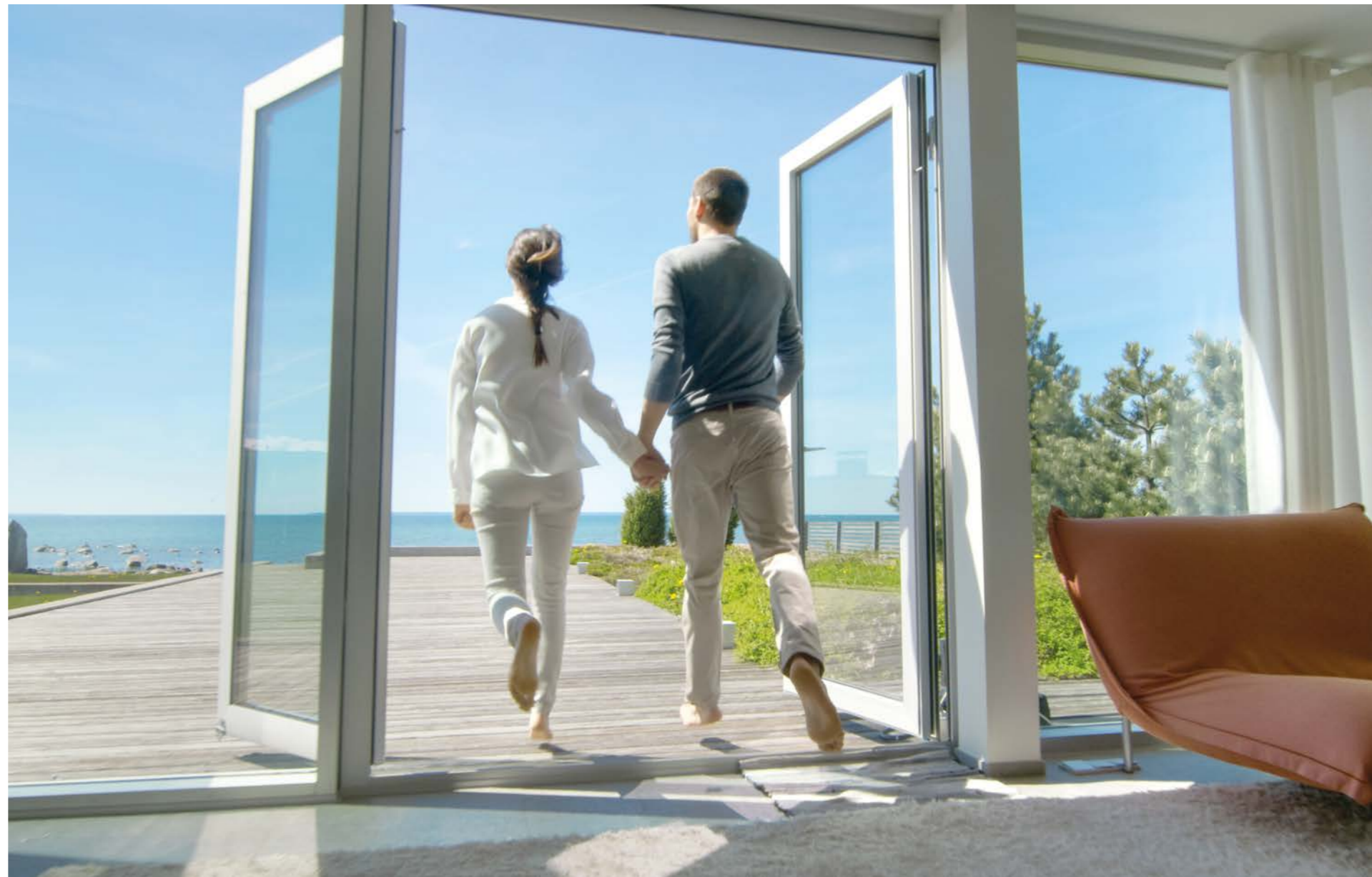
150 / 200 kg



The MB-86 window and door system is a product that meets many needs of users.

- 
 Maximum dimensions of the window sash:
 - L to 1700 mm
 - H to 2800 mm
- 
 Maximum dimensions of the door sash:
 - L to 1400 mm
 - H to 3000 mm
- 
 Thickness of the glazing set:
 - frame: 9-61 mm
 - window sash: 18-70 mm
 - door sash: 9-61 mm

Stollar MB-86

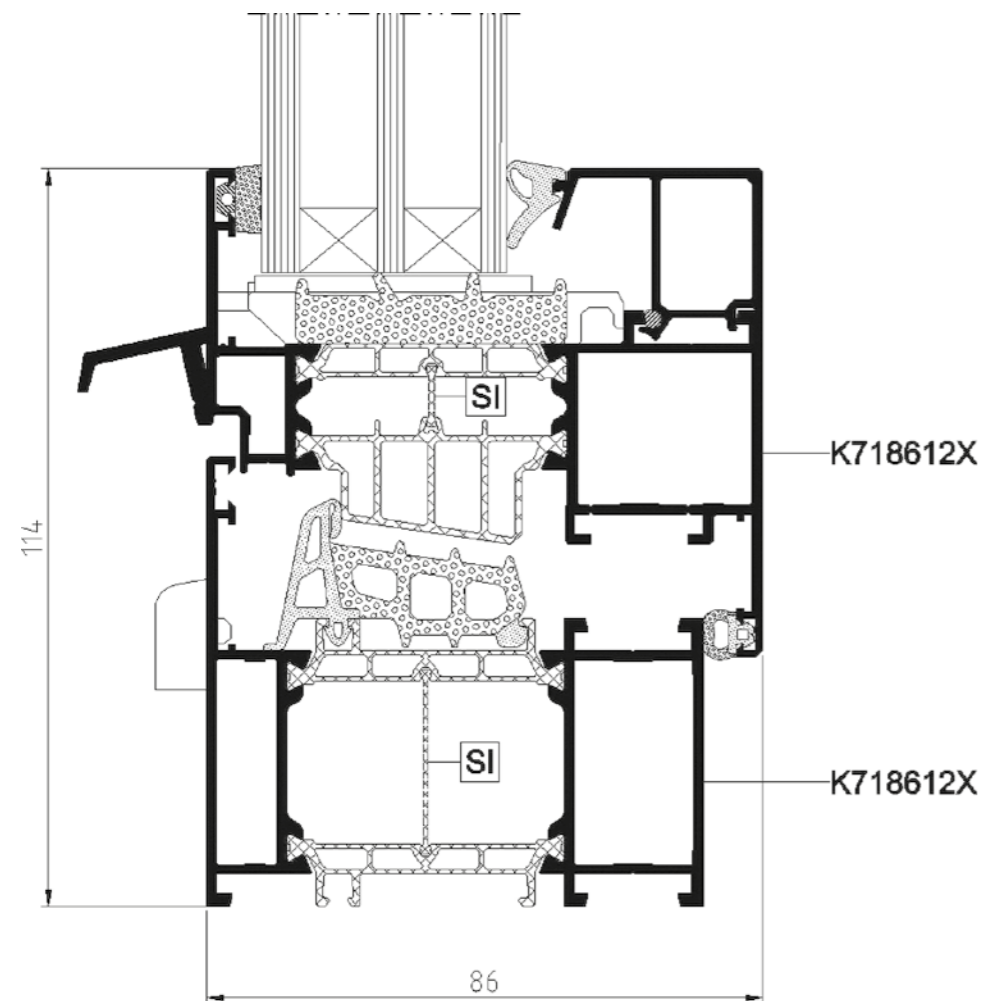

Another advantage of the MB-86 system is the high strength of the profiles, which allows constructions of large dimensions and weight to be made.

The MB-86US version of windows with a concealed casement is also available.

This system is also the basis for the MB70 CASEMENT construction – windows opening outwards.

Stollar MB-104

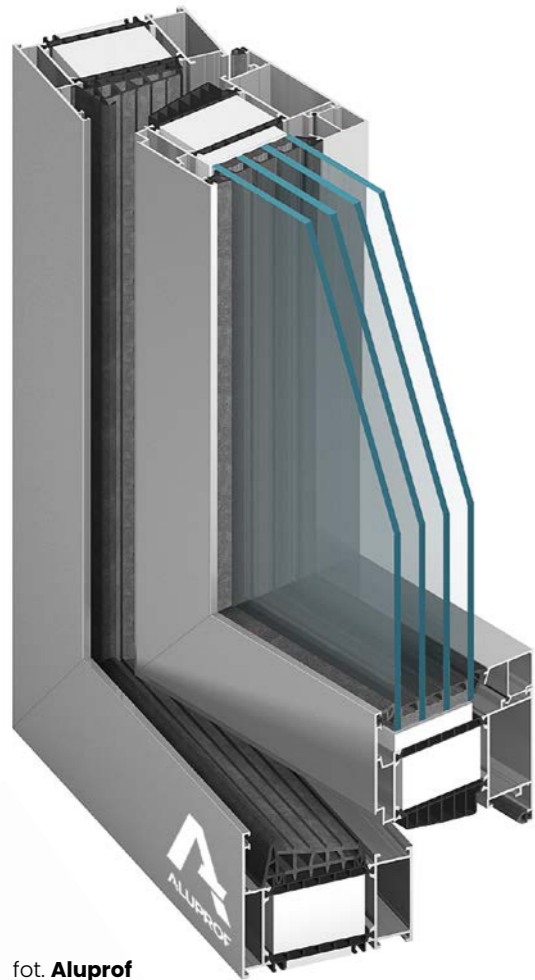

phot. Aluprof

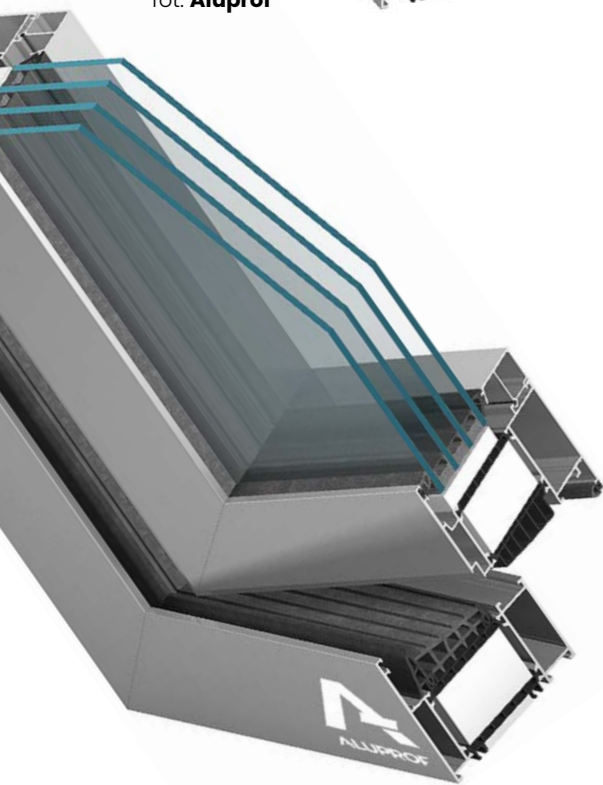

$U_w = > 0,53 \text{ W}/(\text{m}^2\text{K})$



95 mm



160 / 200 kg



The MB-104 Passive window and door system with a thermal barrier, with the highest thermal insulation performance, meets all the requirements for elements used in passive construction.



Maximum dimensions of the window sash:

- L to 1700 mm
- H to 2900 mm



Maximum dimensions of the door sash:

- L to 1400 mm
- H to 3000 mm



Glazing thickness:

- frame: 27–71 mm
- window sash: 31–80 mm
- door sash: 27–71 mm

Stollar MB-104

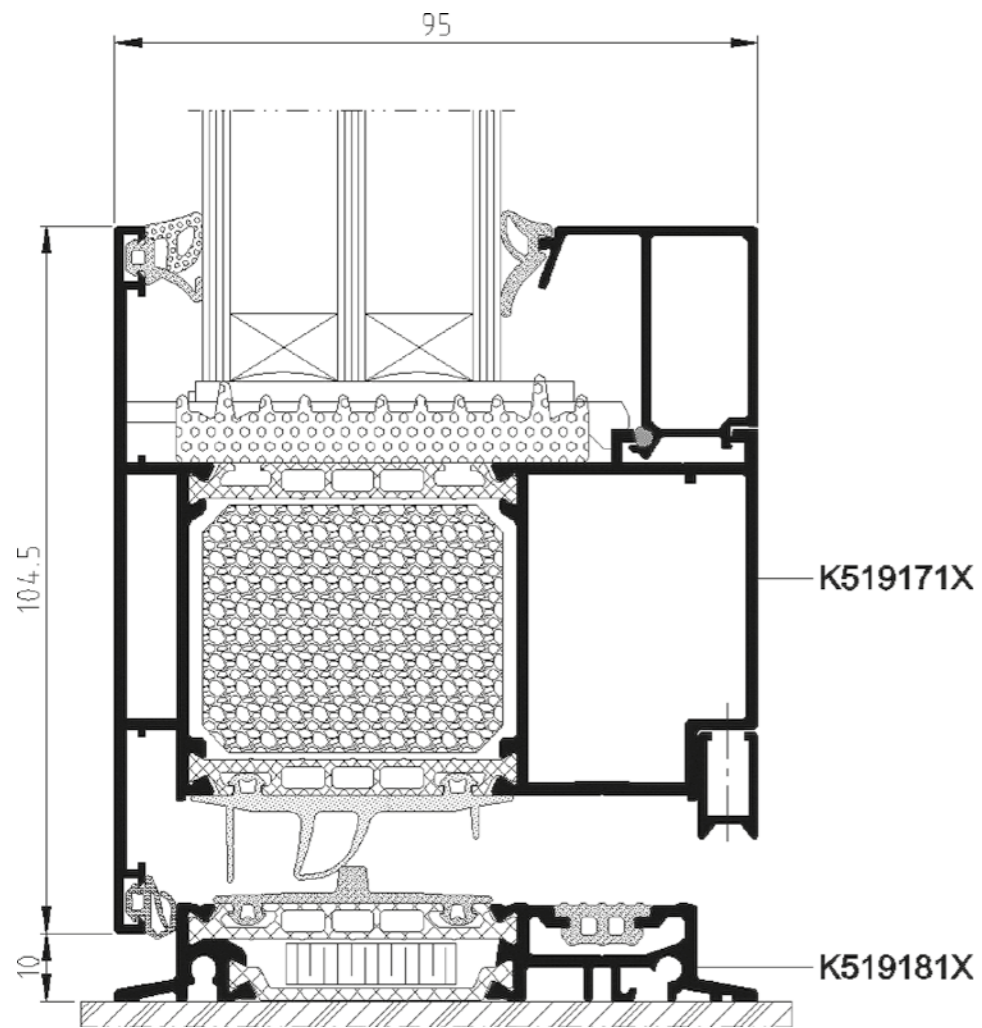

The system is used to make exterior architectural elements, such as various types of windows, doors, vestibules, display windows and spatial structures, which are characterised, apart from excellent thermal insulation, by very good sound insulation, water and air tightness and high structural strength.

Comparison of systems



MB-45

MB-70

MB-79

MB-86

MB-104

	Heat transfer	Uw = 2,3 W/m ² K*	Uf = > 1,0 W/m ² K*	Uf = > 0,83 W/m ² K*	Uw = > 0,72 W/m ² K*	Uw = > 0,53 W/m ² K*
	Installation depth	45 mm	70 mm	70 mm	77 mm	95 mm
	Max. casement weight	120 kg	120 / 130 kg	160 / 200 kg	150 / 200 kg	160 / 200 kg
	Max. size of a window/door casement	L to 1400 mm H to 2400 mm (door casement)	L to 1600 mm, H to 2500 mm / L to 1300 mm, H to 2400 mm	L to 1700 mm, H to 2700 mm / L to 1400 mm, H to 2800 mm	L to 1700 mm, H to 2800 mm / L to 1400 mm, H to 3000 mm	L to 1700 mm, H to 2900 mm / L to 1400 mm, H to 3000 mm
	Glazing thickness	frame: 2-25 mm sash: 2-25 mm	frame: 15-53 mm window sash: 24-62 mm door sash: 15-53 mm	frame: 2-54 mm window sash: 11-63 mm door sash: 2-54 mm	frame: 9-61 mm window sash: 18-70 mm door sash: 9-61 mm	frame: 27-71 mm window sash: 31-80 mm door sash: 27-71 mm

* for the reference window

SLIDING systems

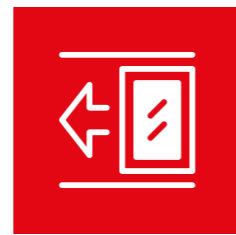

Stollar MB-59HS



foto. Aluprof



$U_f = > 1,8 \text{ W/m}^2\text{K}$

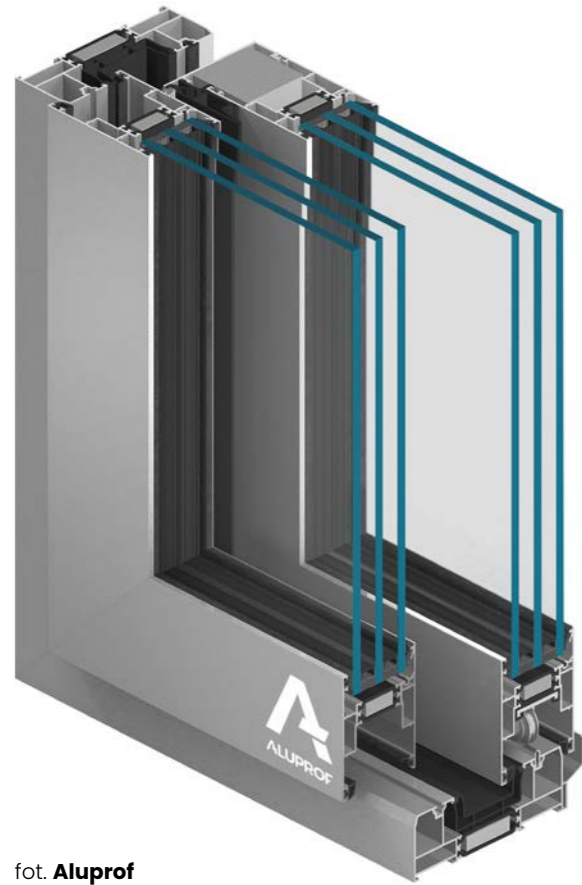
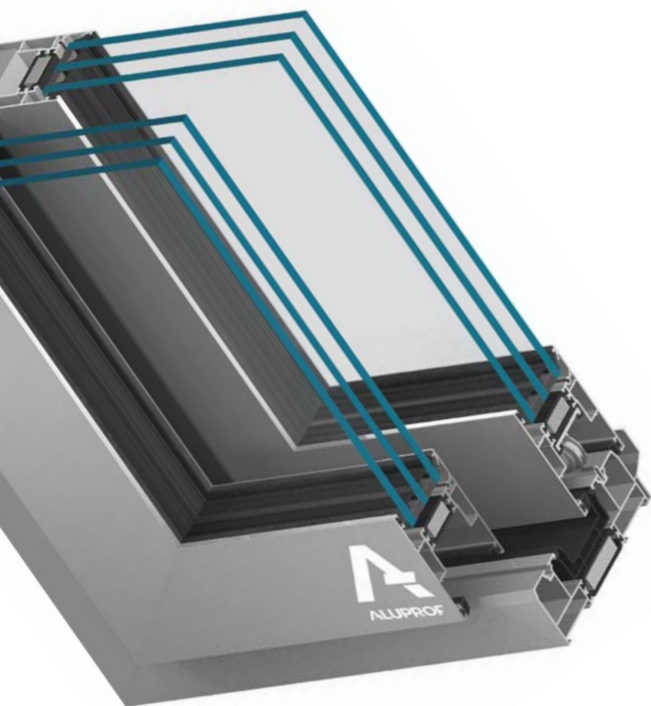

120 mm



300 kg



Lift-and-slide doors are an ideal solution for connecting rooms or conservatories with the outside environment, they are convenient exits to the balcony, terrace or open garden space.



Maximum sash dimensions:

- L to 3300 mm
- H to 2800 mm



Possibility of fixed glazing in frame or sash.



Glazing thickness:

- 10–42 mm

Stollar MB-59HS

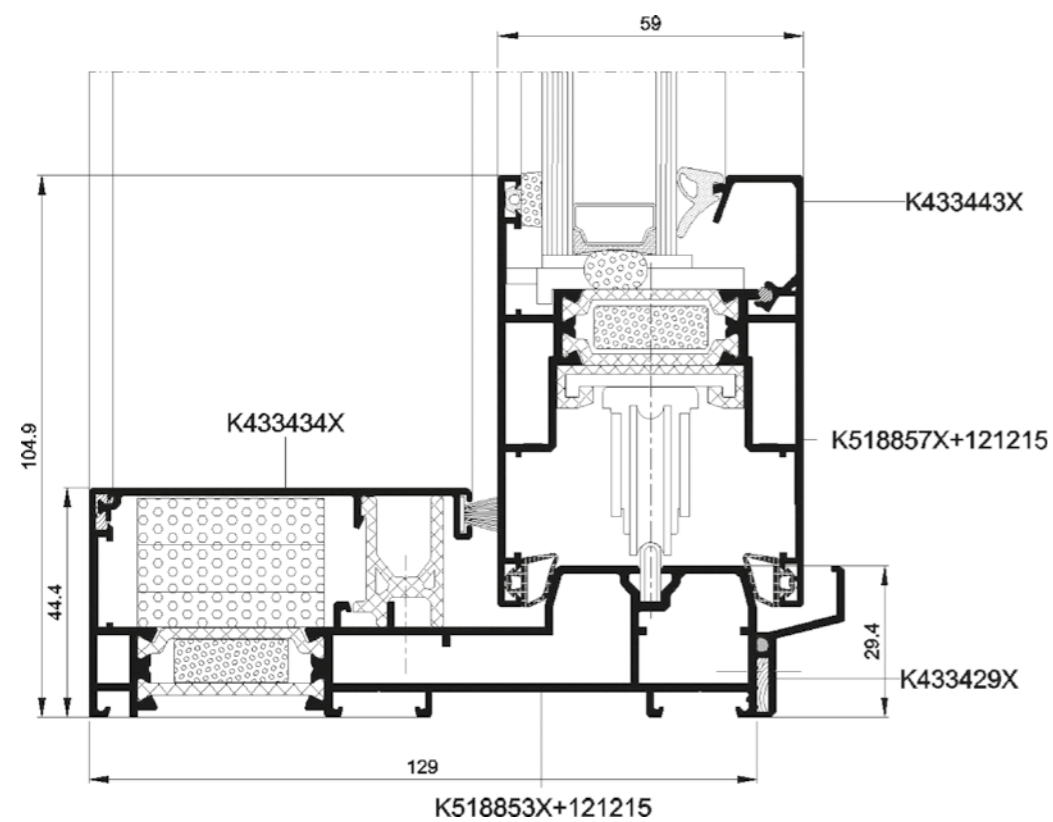

The MB-59HS system offers great constructional possibilities for lift and slide doors, while at the same time being an optimised solution in terms of the structure and dimensions of casement and frame profiles.

The MB-59HS system sections have two construction variants differing in thermal insulation: ST and HI.

The range of available profiles includes two- and three-rail frames.

Stollar MB-77HS



foto. Aluprof



$$U_w = > 0,84 \text{ W}/(\text{m}^2\text{K})$$

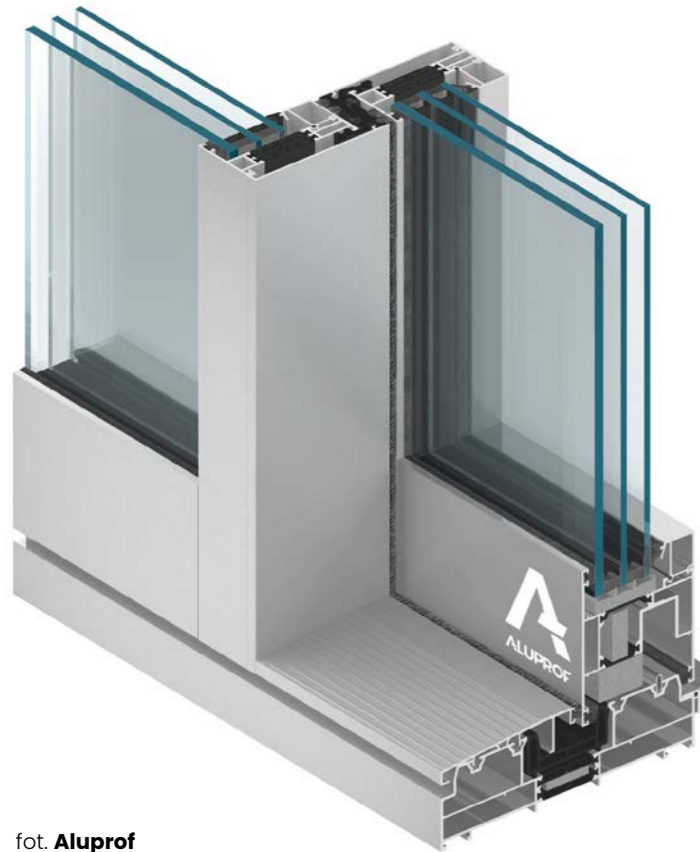
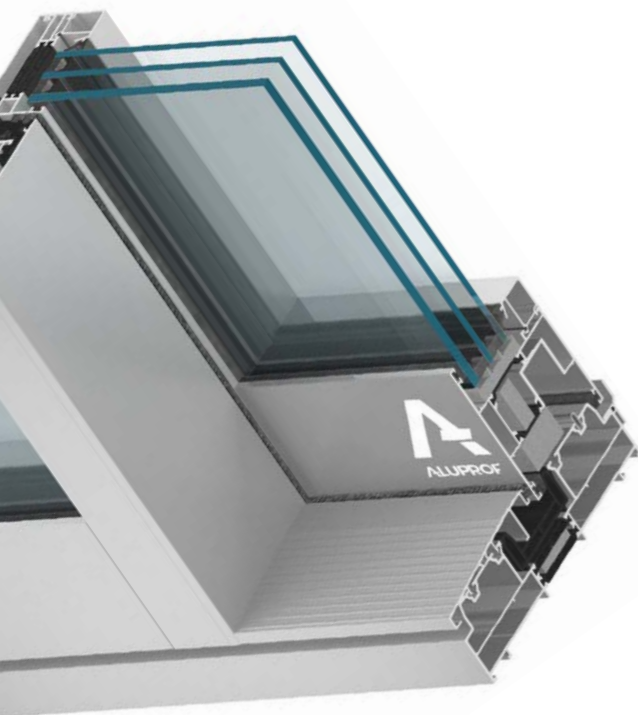

174 mm



600 kg



Lift and slide doors enable very good contact with the surroundings, and in the open position they do not take up space inside the room, which additionally increases their comfort.



Maximum sash dimensions:

- L to 3300 mm
- H to 2800 mm



Possibility of fixed glazing in frame or in the sash.



Glazing thickness:

- 9–61 mm

Stollar MB-77HS

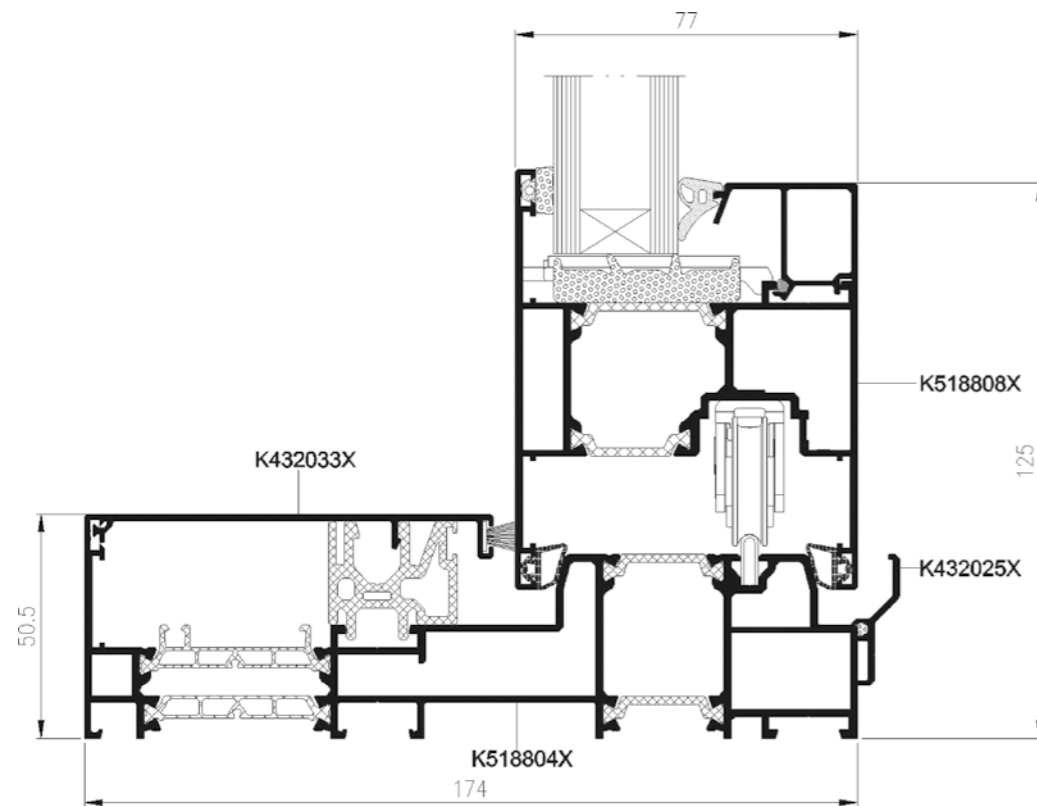

The MB-77HS system is one of the best performing products and meets all the requirements for this product group. The construction of profiles allows for making exclusive large size doors filled with single or double glazing.

The used materials and technical solutions help to achieve a high degree of thermal and acoustic protection. Thanks to its properties, this system is ideal for single-family houses as well as comfortable flats or hotels.

FIRE PROTECTION system



Stollar MB-78EI



foto. Aluprof



$$U_f = > 1,6 \text{ W}/(\text{m}^2\text{K})$$



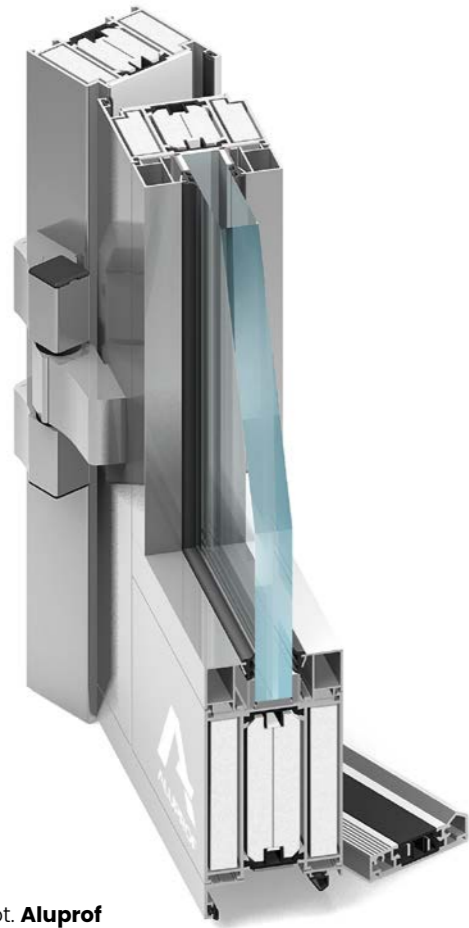

78 mm



EI 15, EI 30, EI 60



MB-78EI system is used to make internal or external fire partitions with single and double sash doors of fire resistance class EI 15, EI 30, EI 60.

-  The range of permissible structural dimensions includes fixed partitions up to 4000 mm high and hinged doors with sash dimensions up to 1400 x 2500 mm.
-  Fire resistance classes:
 - EI 15
 - EI 30
 - EI 60
-  Glazing thickness:
 - 8-49 mm

Stollar MB-78EI

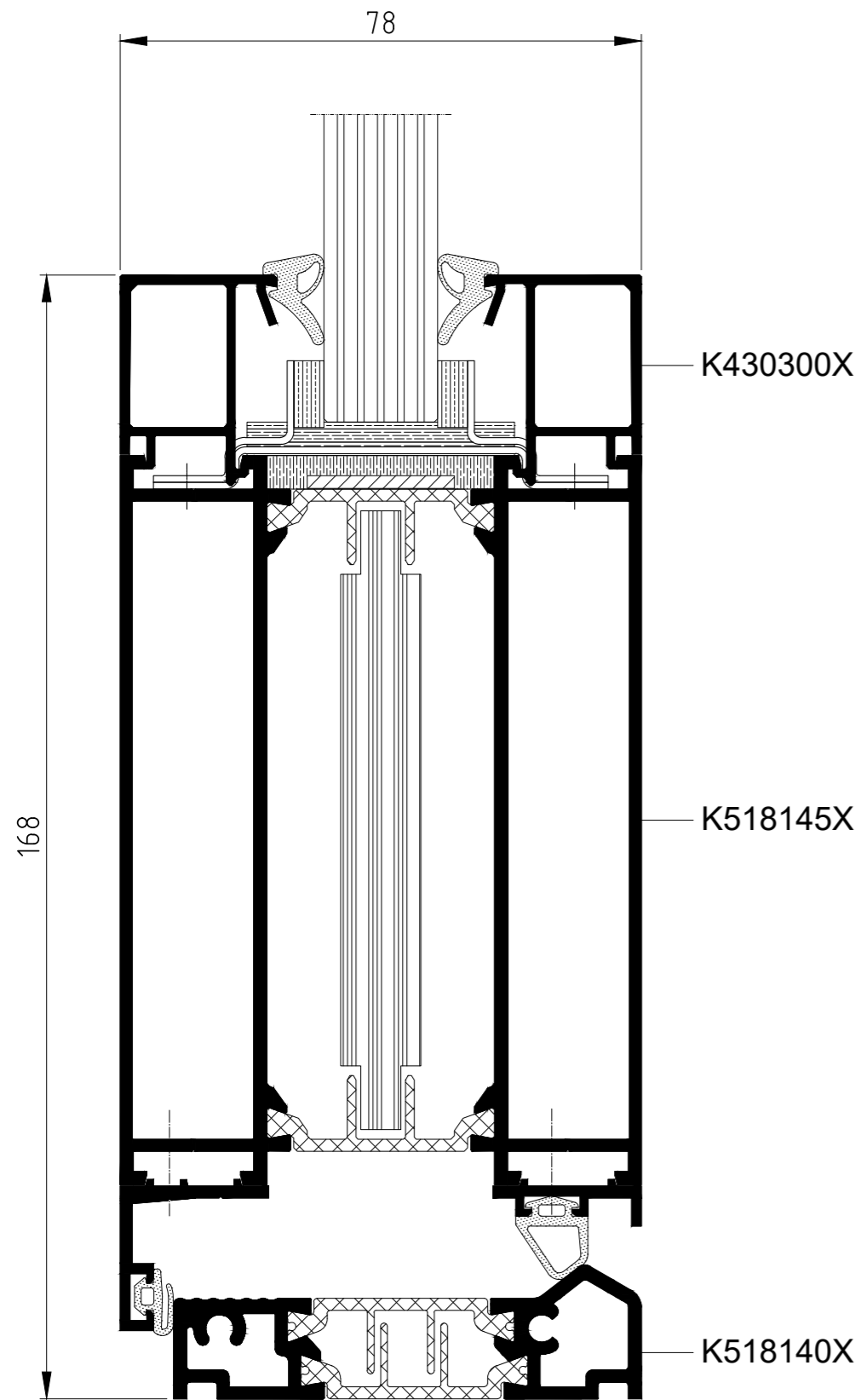

The fillings can be all typical fire resistant glazing as well as opaque sandwich elements composed of sheet metal and suitable panels, providing the required fire protection. Smoke-proof structures can also be achieved with this system.

Additionally
IN OUR OFFER



Stollar MB-SLIMLINE



foto. Aluprof



$$U_w = > 0,8 \text{ W}/(\text{m}^2\text{K})$$

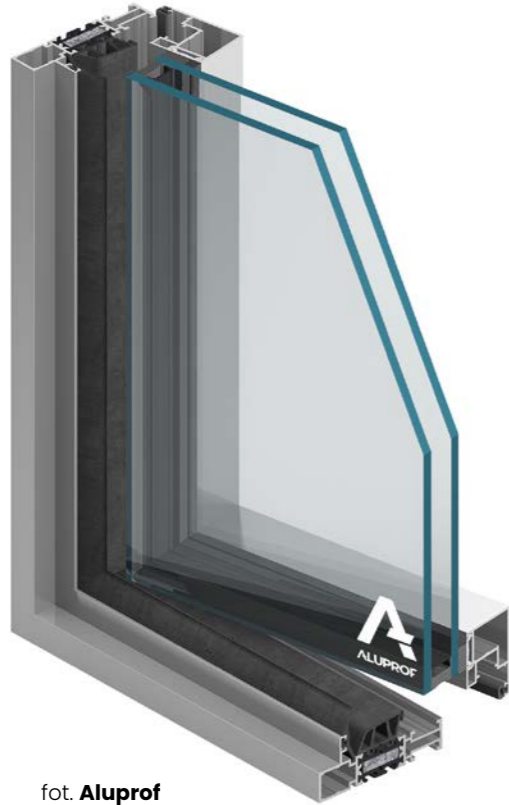

68,5 – 90,5 mm



< 81 mm



$$U_f = > 1,5 \text{ W}/(\text{m}^2\text{K})$$



77 – 110 mm



< 61,5 mm

Stollar MB-FERROLINE



foto. Aluprof

Stollar MB-86 FOLD LINE



foto. Aluprof



$$U_d = > 1,1 \text{ W}/(\text{m}^2\text{K})$$

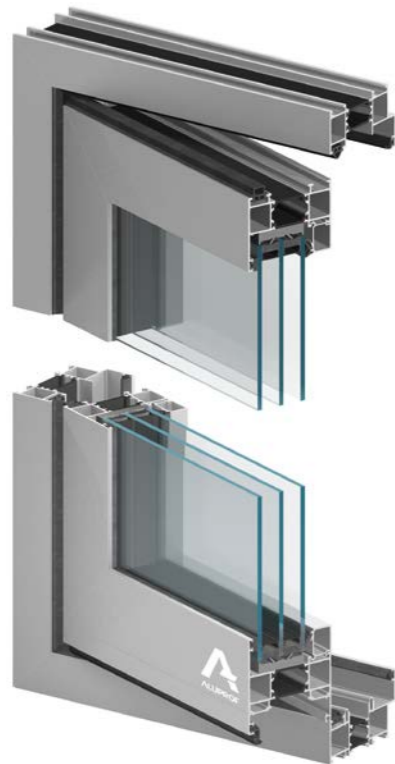

77 mm



< 61,5 mm



$$U_f = > 0,59 \text{ W}/(\text{m}^2\text{K})$$



< 64 mm

Stollar MB SR50N HI+



foto. Aluprof

MANY COLORS to choose from

In addition to the colors indicated, we also have
in our offer full RAL palette and anodized colors.

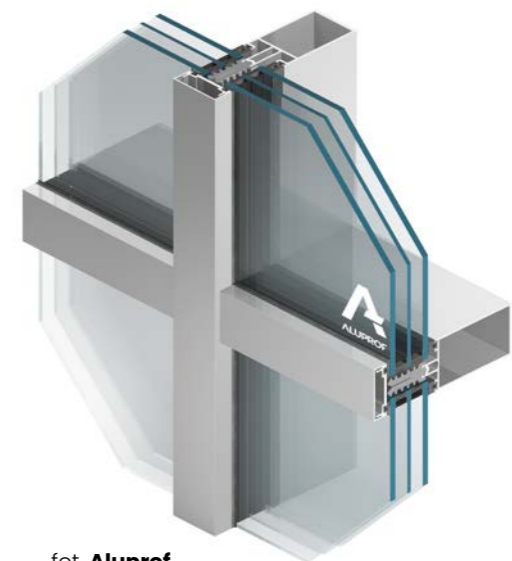

Standard colour palette



RAL 7016

RAL 8019

RAL 9005



RAL 9006

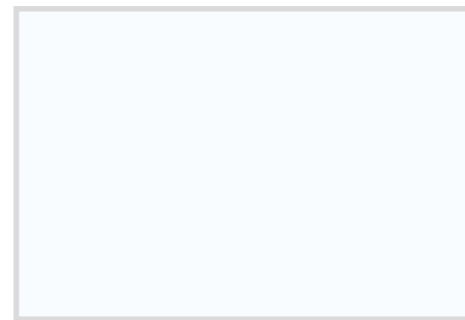

RAL 9016

Woodgrain colour palette

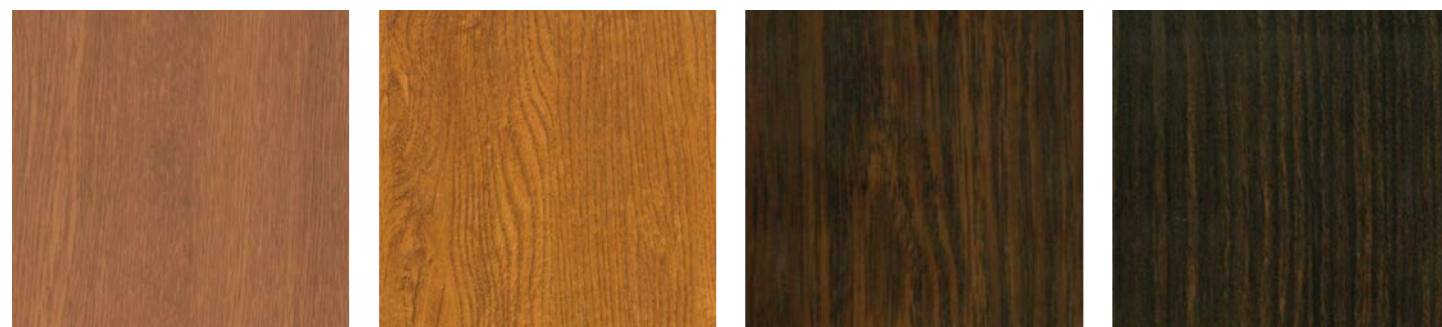

ADEC D101
Golden Oak

ADEC D210
Rustic Oak

ADEC D502
Swamp Oak

ADEC M102
Ebony

NOTE! The colors may slightly differ from the finished product.



ADEC 0102
Walnut

ADEC M103
Mahogany

ADEC M204
Sapelli Mahogany

ADEC O205
Vein Walnut



ADEC S106
Pine

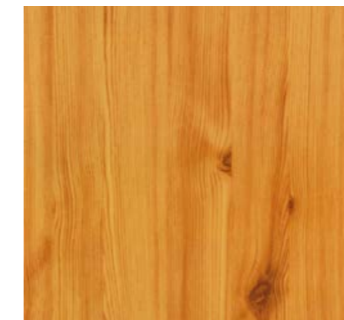

ADEC S110
Pine



ADEC J107
Fir



ADEC S208
Fir



ADEC B108
Beech

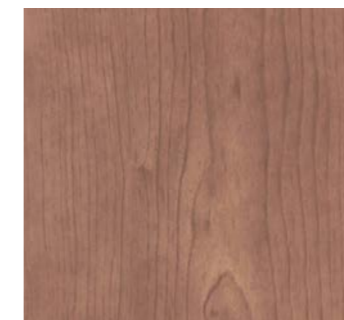

ADEC W109
Cherry



ADEC W205
Wege

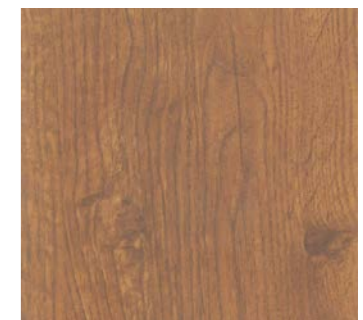

ADEC D207
Winchester

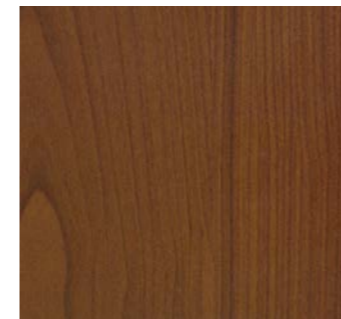

ADEC C106
Dark Cherry

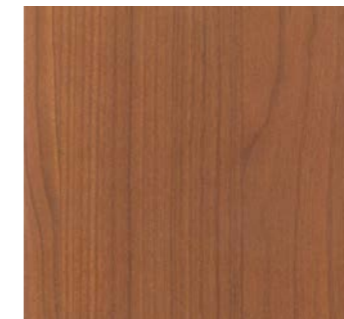

ADEC C110
Sweet Cherry



ADEC C212
Sweet Cherry

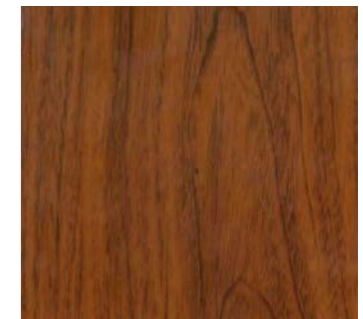

ADEC K101
Chestnut

STOLLAR Window Systems

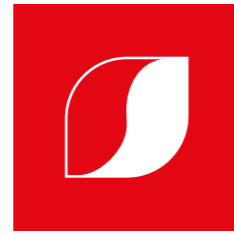

The home has an important place in the human heart.

Everyone spends most of their free time there, relaxing in the comfort of a properly lighted and pleasant interior.

That is why we make every effort to ensure that our products satisfy the most demanding tastes and care for the convenience of use of all our customers.

Our windows guarantee high comfort and will transform any interior into a house full of splendor, warmth and elegance.





Every person on our team cares about the comfort of both colleagues and customers.